

THE LAYER MONUMENT OF SNOFRU AT SEILA

- During 2 seasons, the remains of the monument of Snofru at Seila have been excavated exposing the present measurements and heights above sea level. The original measurements are known from the reconstructions suggested.
- The reconstructions options are: a step pyramid or a benben. They have been drawn from information of a plan of the aerial view of the monument, 2 elevations of the north and west sides and 3 profiles sections east west and one profile section on the south side.
- Important stone objects from the nucleus and the outer facing were mixed with the rubble accumulated around and above the monument. The study of their shapes made us realize that they were key factors in the reconstruction. The shape of the steps of the pyramid or benben options became clear.
- Other stone objects found were used to correct building irregularities and adjust the sloping angles of the accretion layers.
- Among the many finds were fragments of a seated statue of king Snofru and 2 stele one completely defaced and the other bearing a serekh and a cartouch of that king.
- Religious objects found seem to have been used in rituals performed at a north and an east chapel. These may help us understand the purpose of this monument.
- No indications of a substructure have been found
-

LOCATION

Map of The Nile Fayum Divide

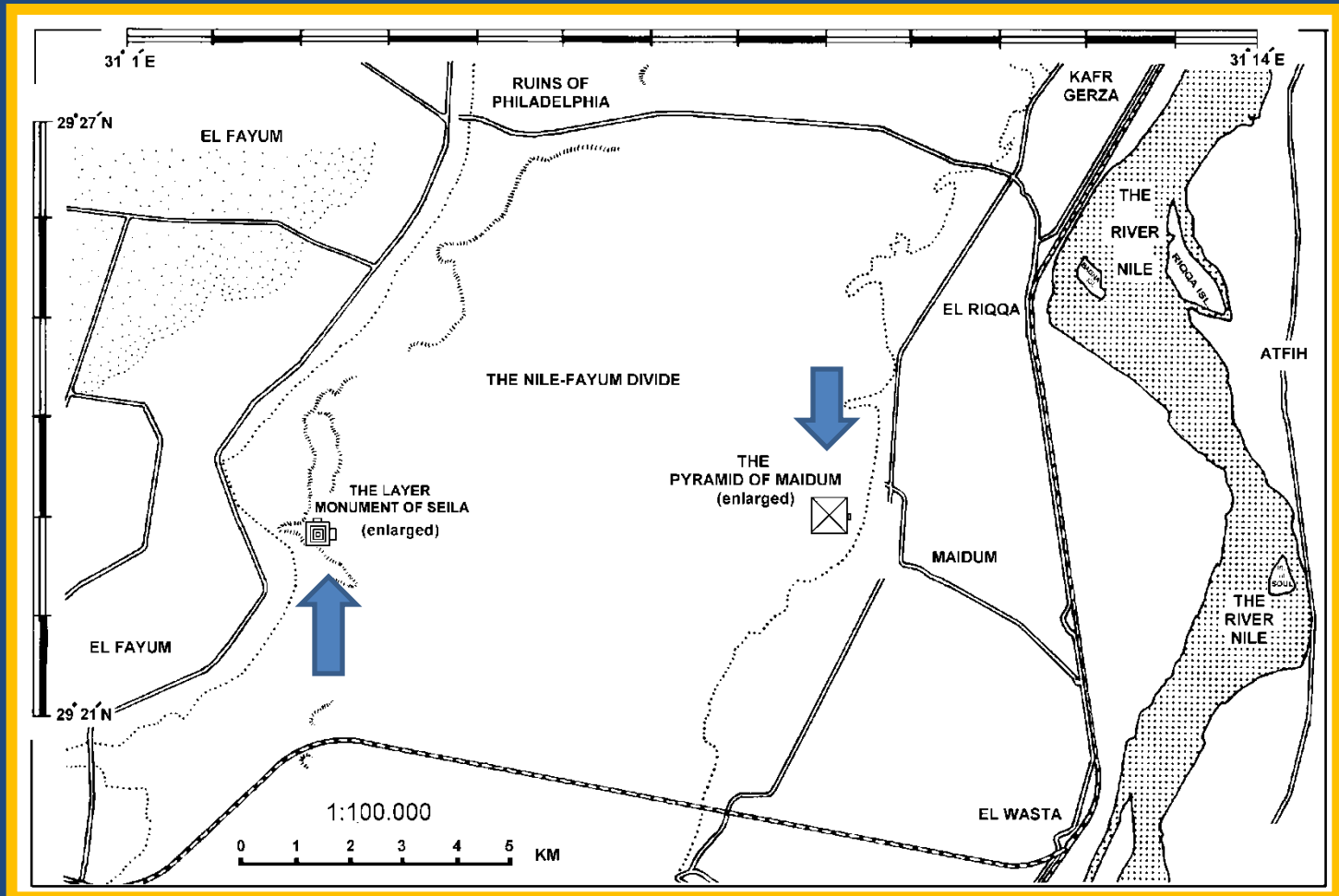

At Seila Masonry and Mortar from the Surrounding Djebel El Rus



LOCATION

Seila



Location on Contour Map and an Icon Showing Relevant Bearings

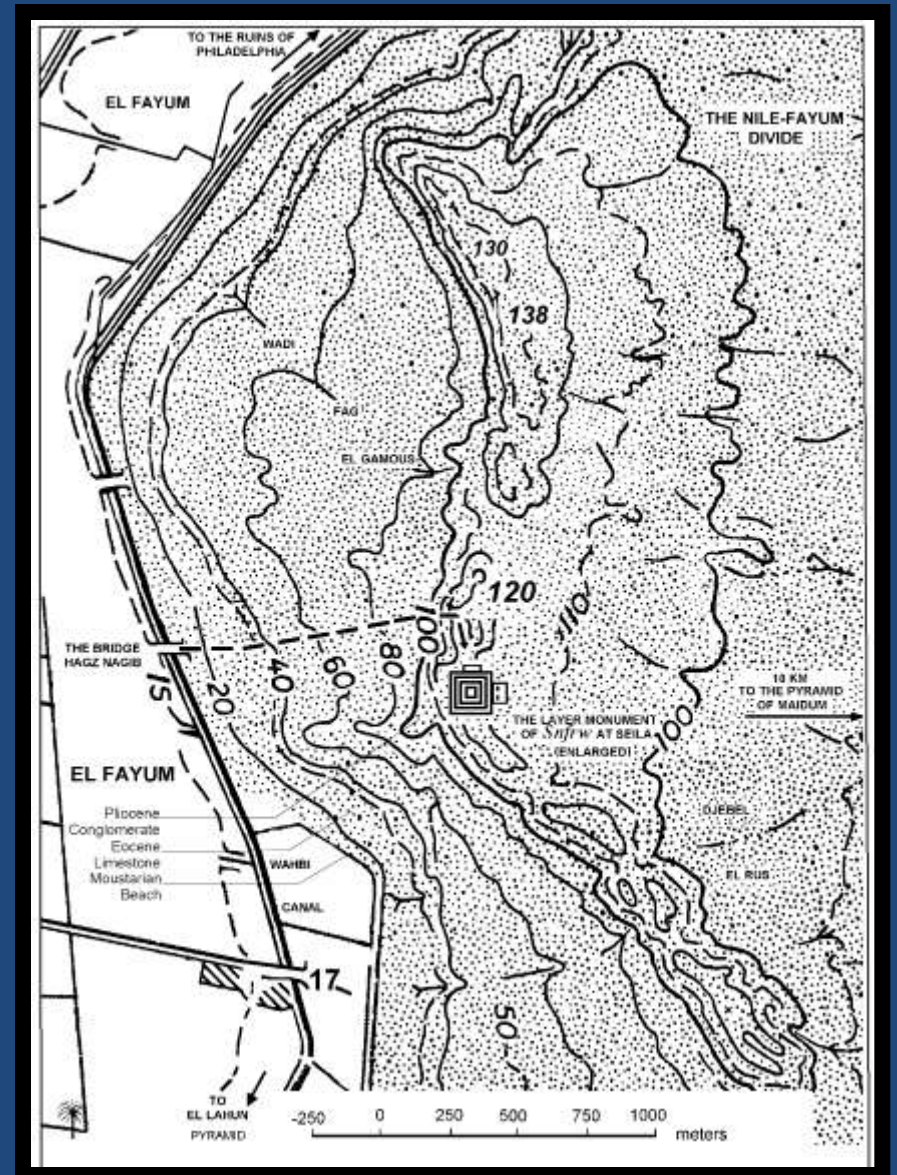
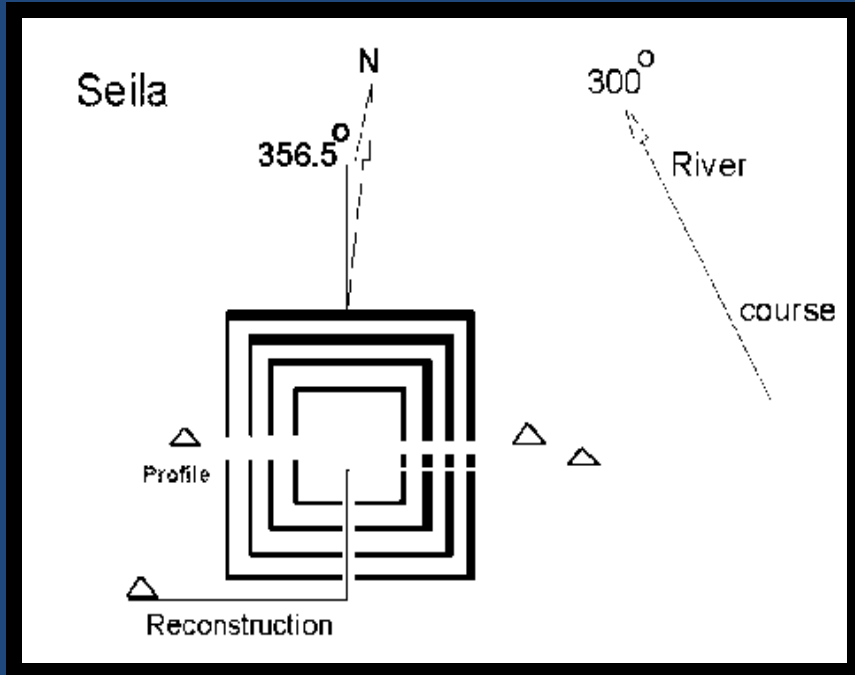

Seila, North, South and West Descending Wadies



Section by Lauer, Plan by Bakai - Lesko

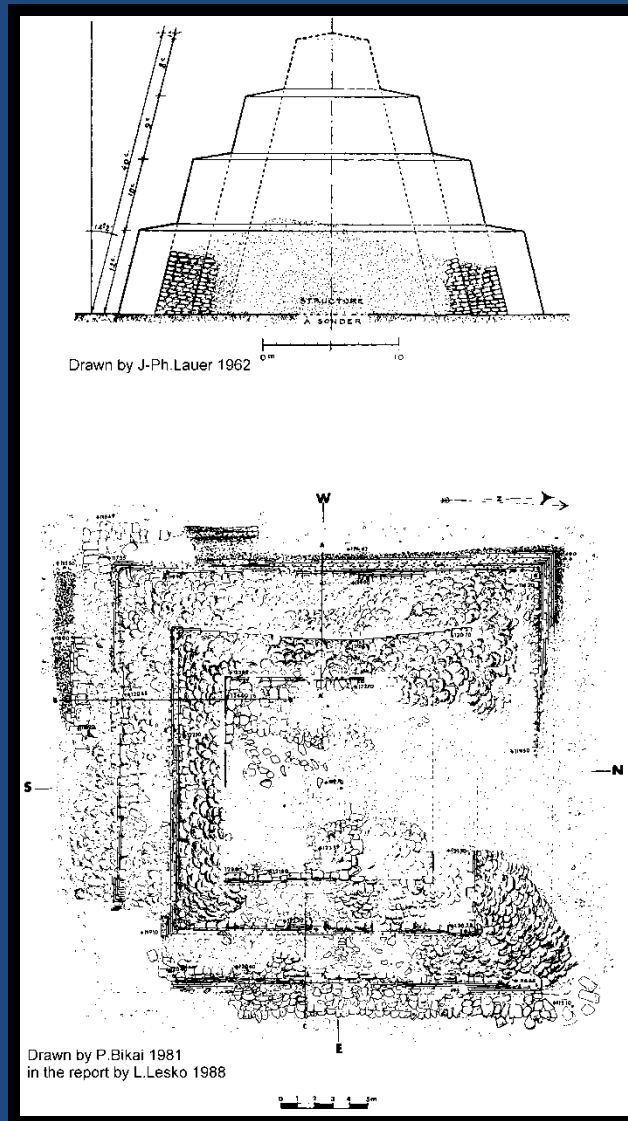

North and South Sides



Robbers Trench



East and West Sides



Funerary Pyramids are Close to Perfection; But

NO ANCIENT RECORDS HAVE BEEN FOUND ON:

1. **PLANNING** of a Funerary Pyramid, Except for some Remote Ones.
2. **LOGISTICS** and Organization of the Building Process.
3. **TECHNIQUES** of Building .
4. **ADMINISTRATION** of the Project.

**NO RECORDS HAVE BEEN FOUND AT THE L. M. BUT,
INTERESTING INFORMATION WAS FOUND ON:**

1. Construction on **UNLEVELED** Rock or **LEVELED** Desert.
2. **CORRECTING** Builders Mistakes **SUPPLIES** of Building Material.
3. Brick **MARKERS** for Planning.
4. **RAMPS** for Construction.
5. **Similarities**

Religious Rituals, Seila: The East Chapel

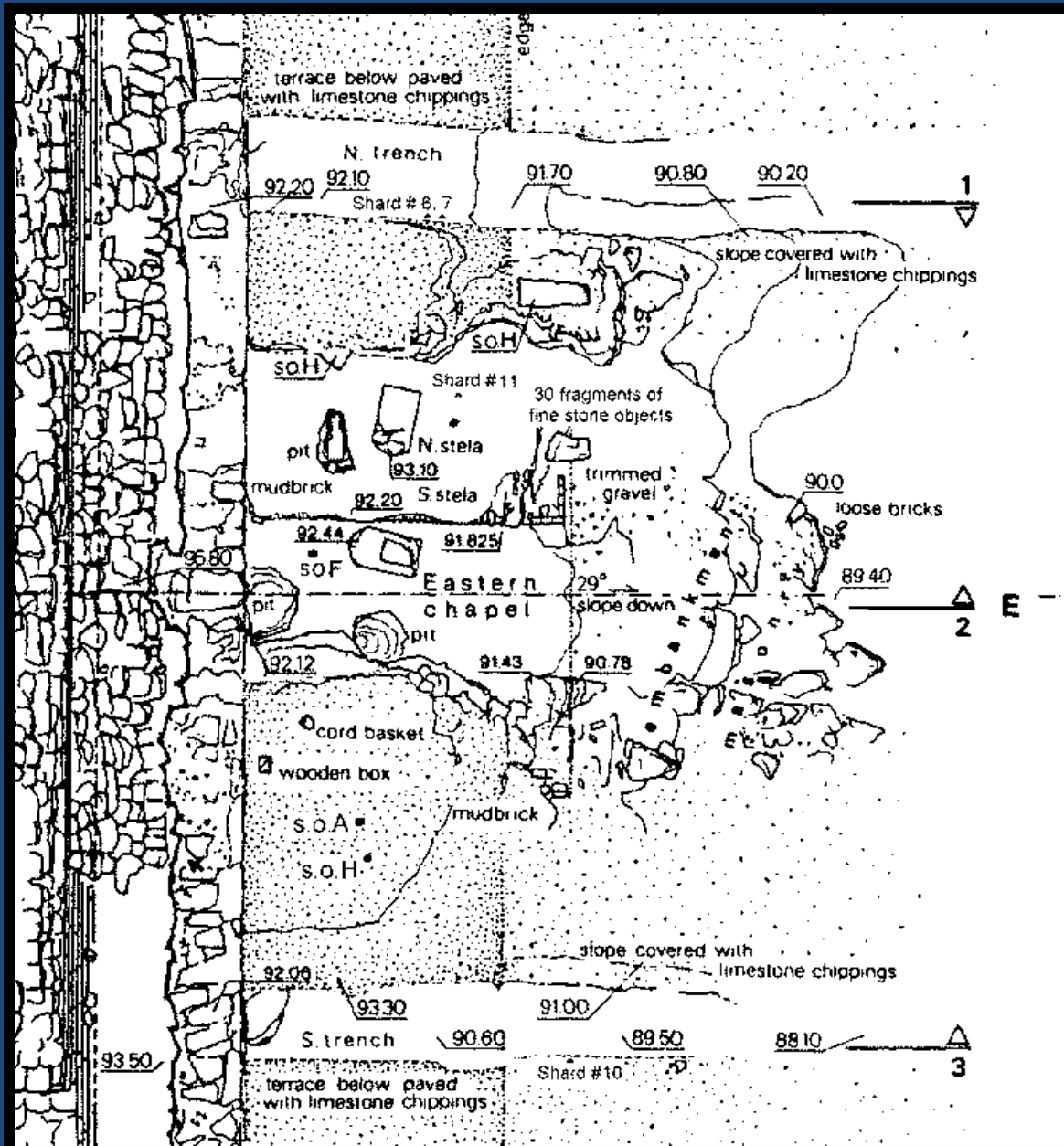

Eastern Chapel

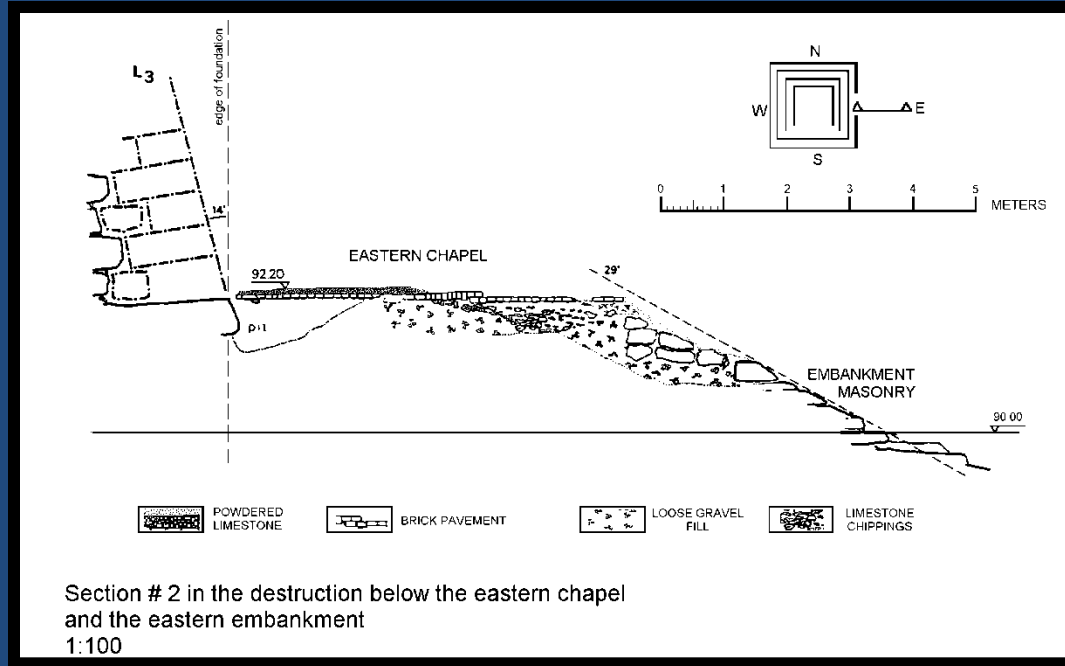

Stele at the Eastern Chapel



Hr Neb Maat
Niswbity
Snofrw

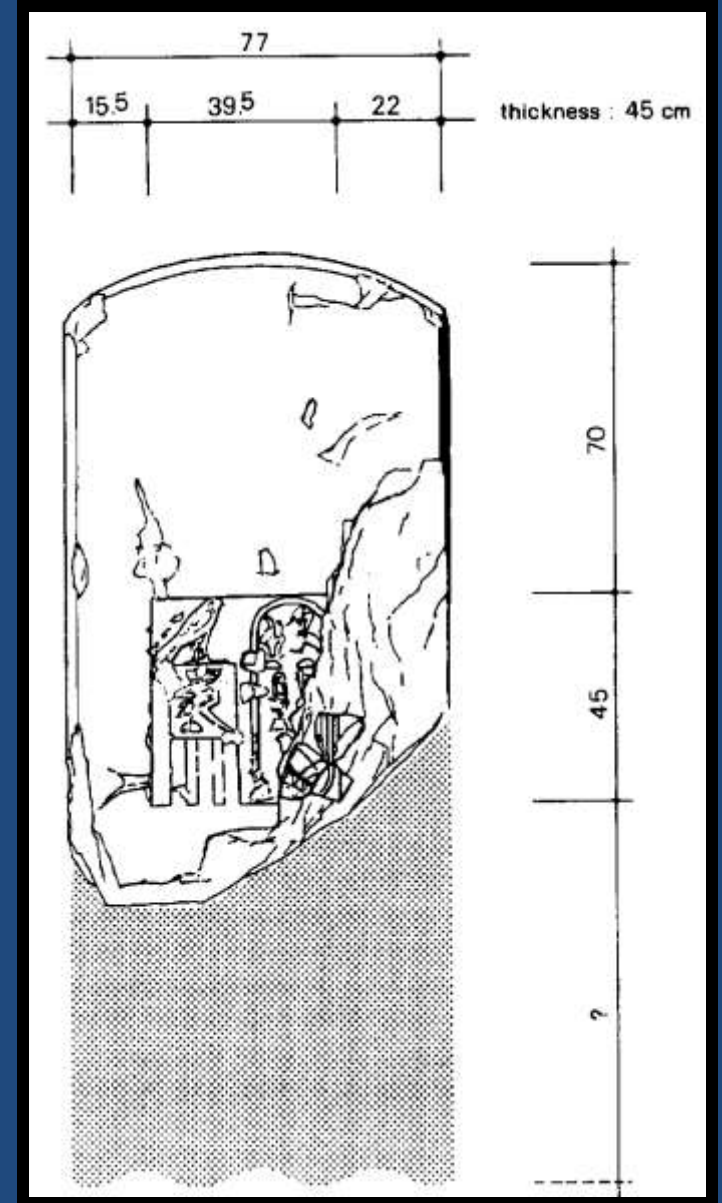

Roof of a Shrine for a Model Boat ? In the Eastern Chapel

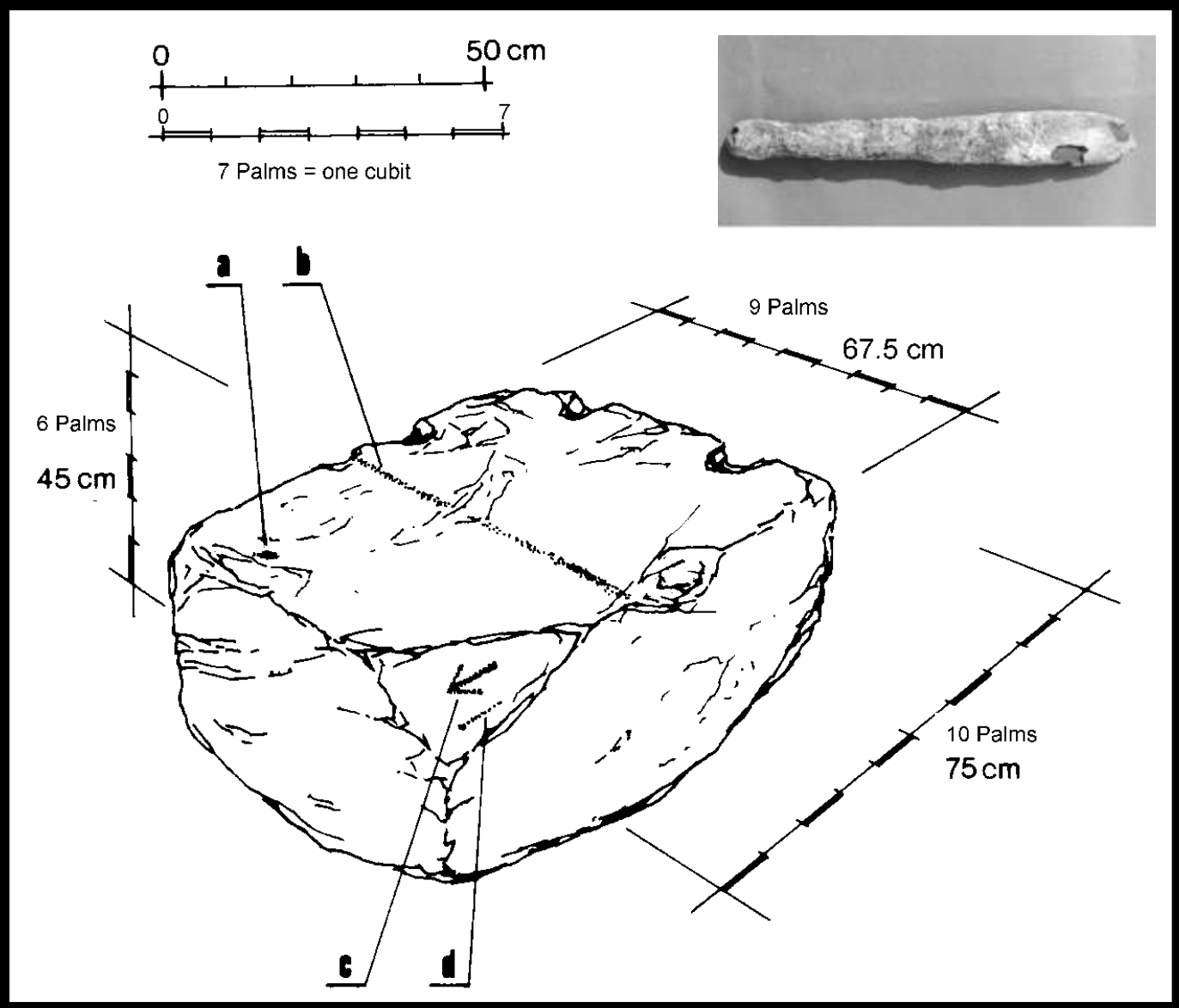

Religious Rituals, Seila: The North Chapel

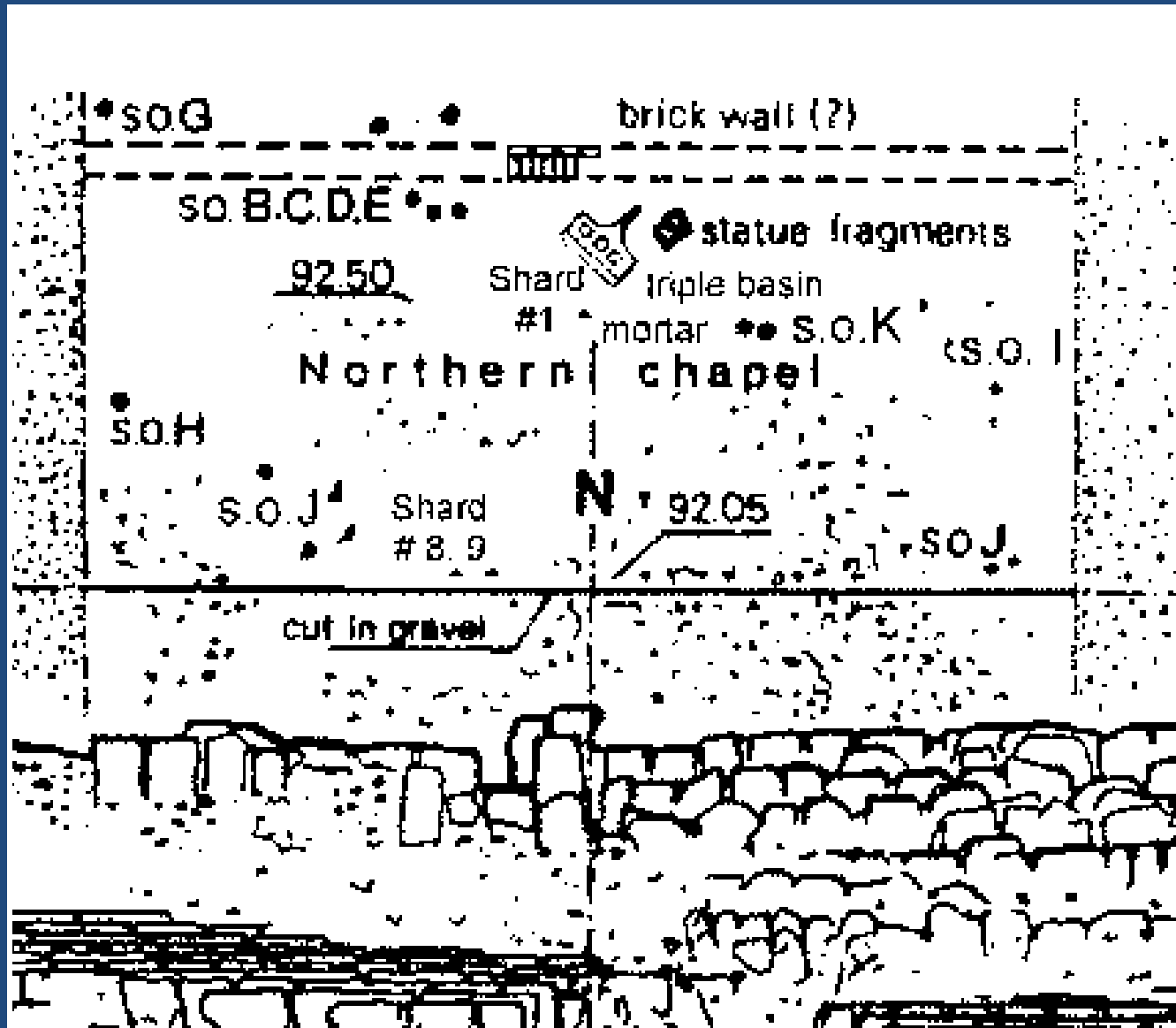

Fragments of a Seated Statue in the Northern Chapel



A Triple Basin from the Northern Chapel

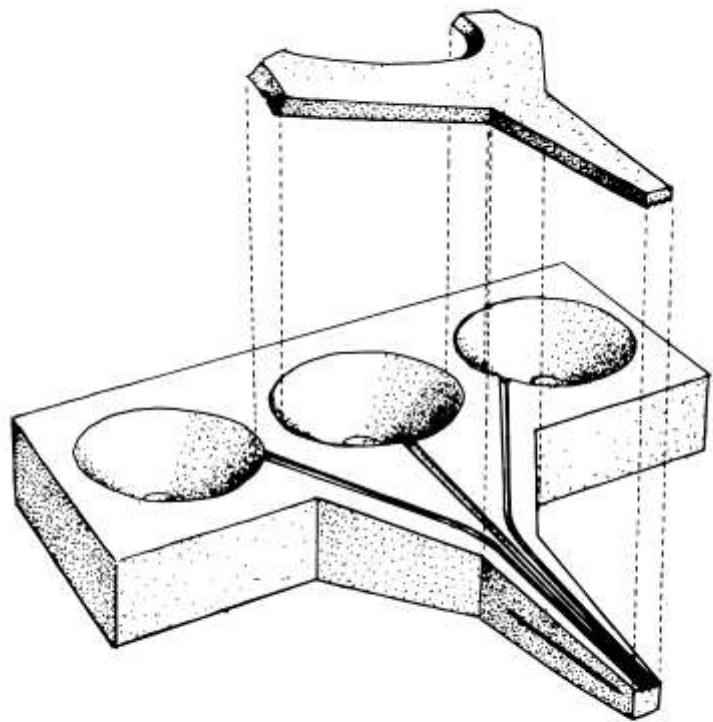

A Stone Table in the Northern Chapel

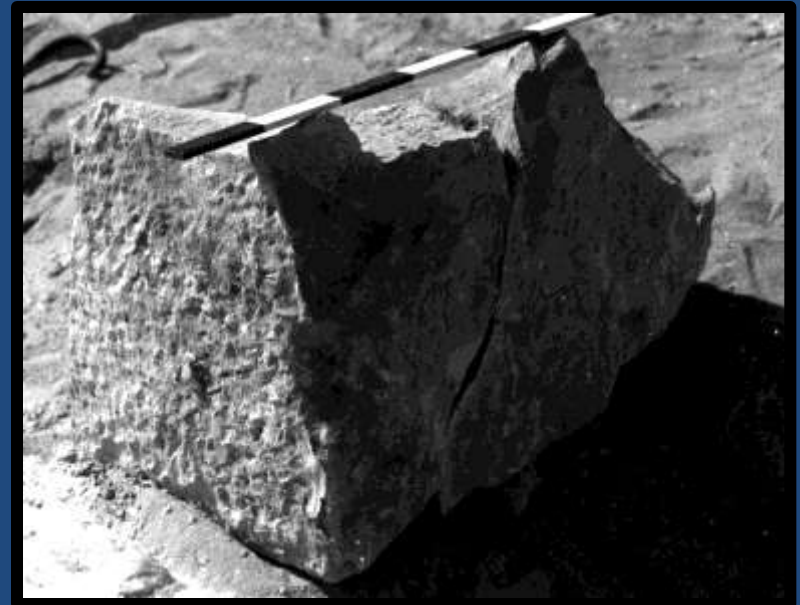
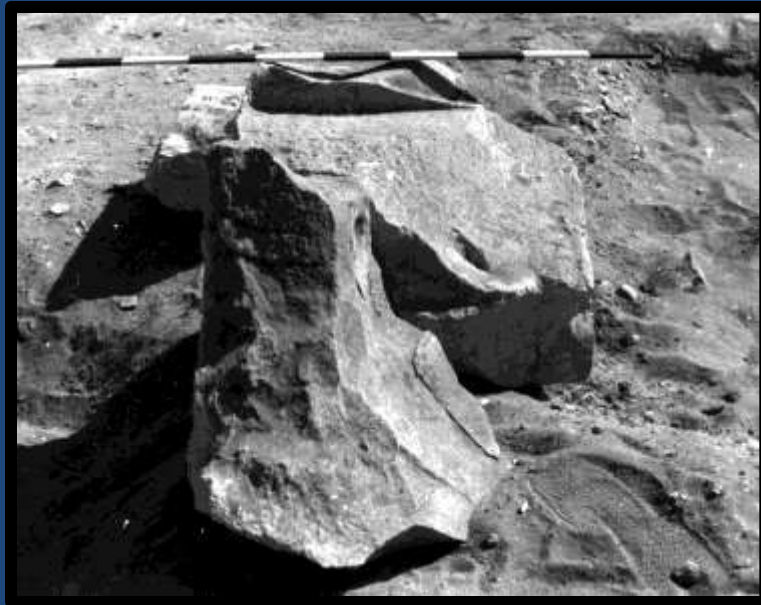
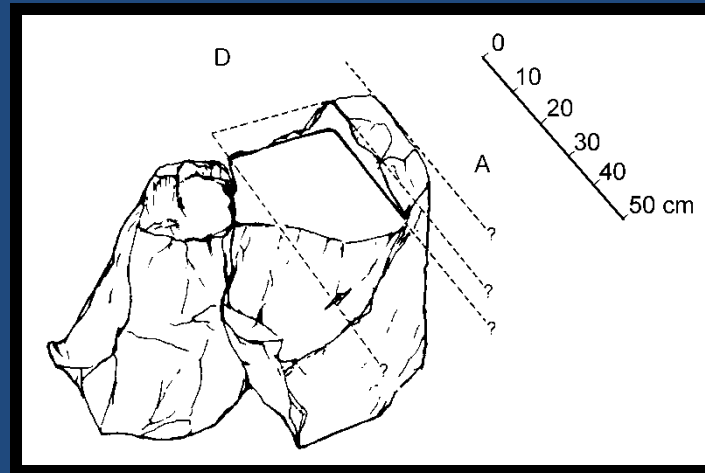

Outer Facing Herders and Stretchers

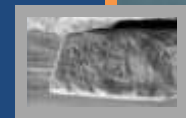
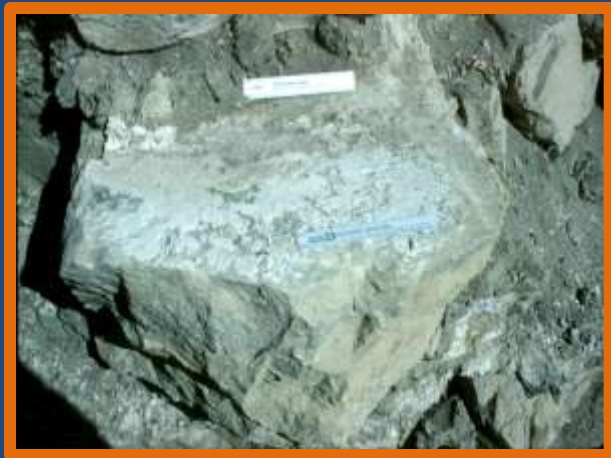
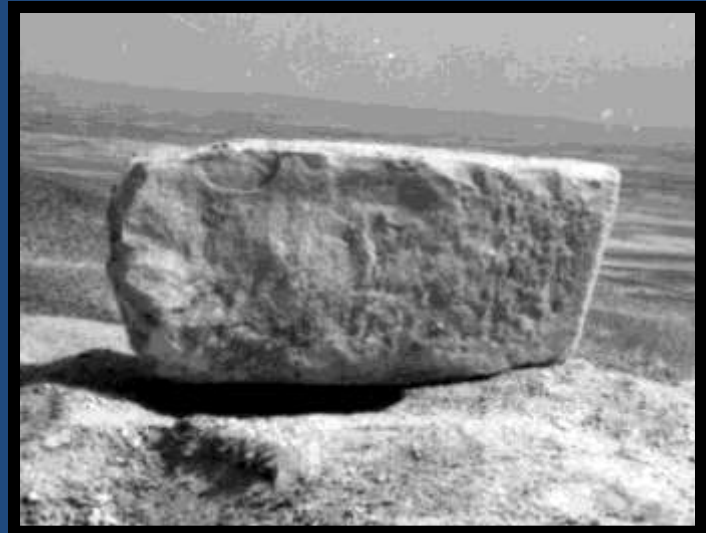

FOUNDATIONS FOR OUTERFACING AT SEILA, SINKI, ELEPHANTINE AND HEBENU

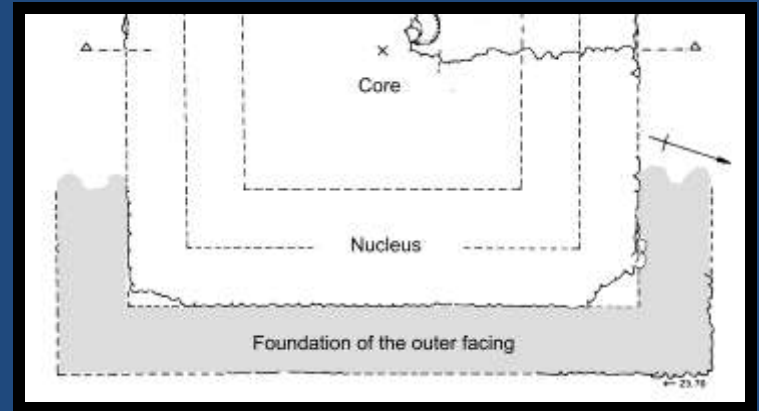

Seila, The Step and Slope: Stone Objects 'B', 'C', and 'H'



RECONSTRUCTIONS

1. ELEVATIONS
2. PROFILE
3. DATUM LEVEL
4. FAULTY SIDE ANGLES
5. THE ULTIMATE SHAPE
6. THE SHAPE OF THE STEP
7. STEP PYRAMID OPTION
8. BENBEN OPTION

1, NORTH ELEVATION

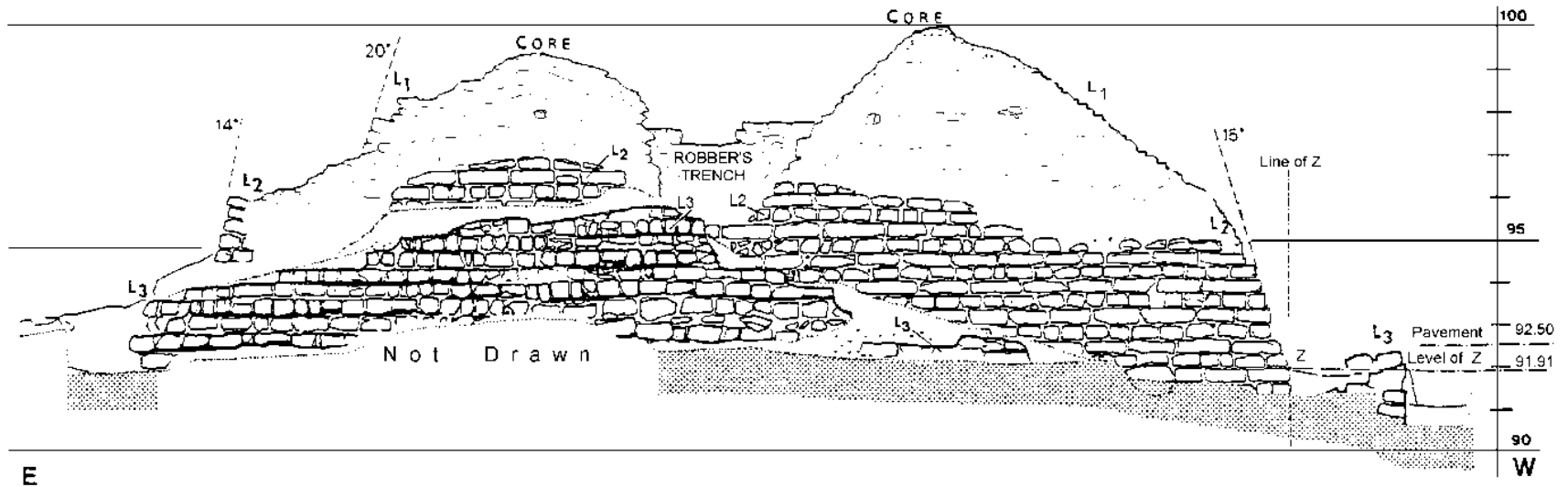
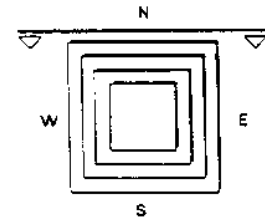

2, THE PROFILE

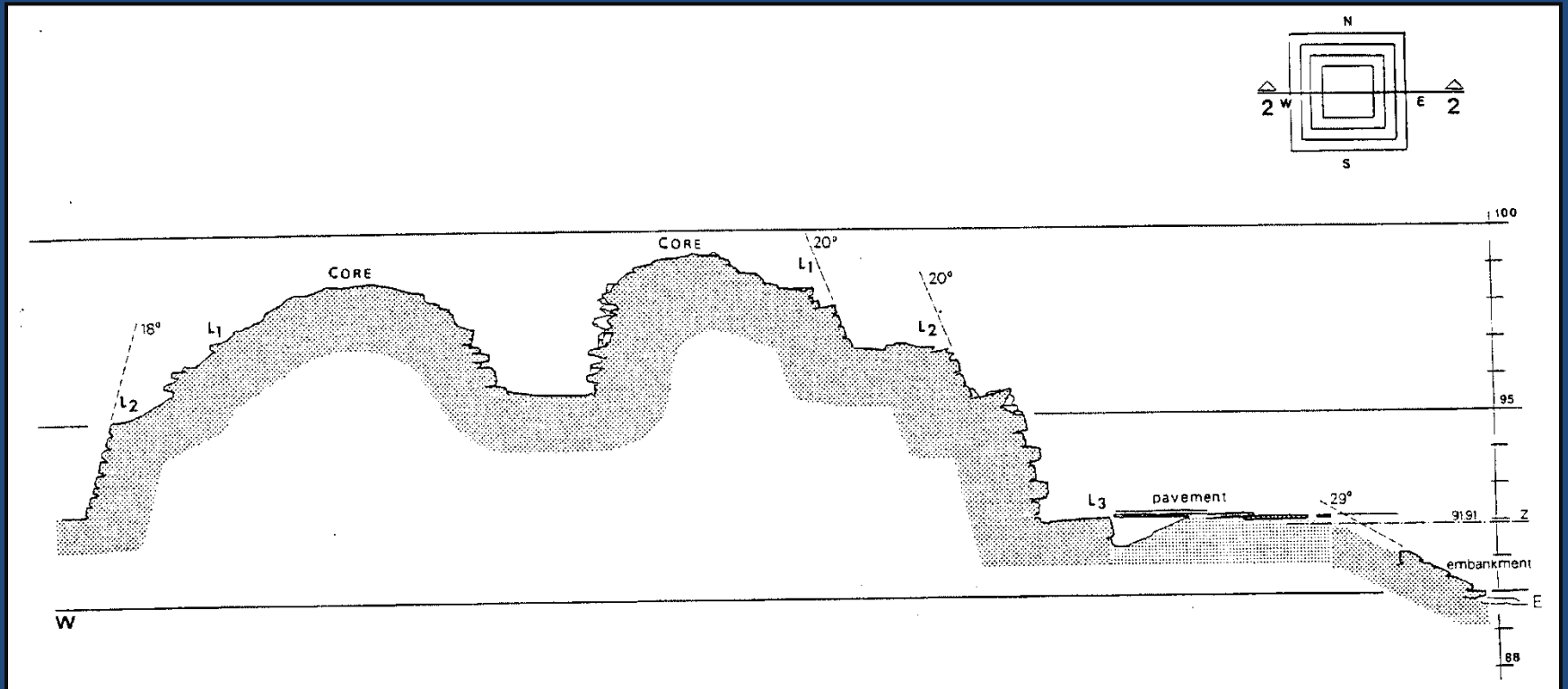

3, DATUM LEVEL

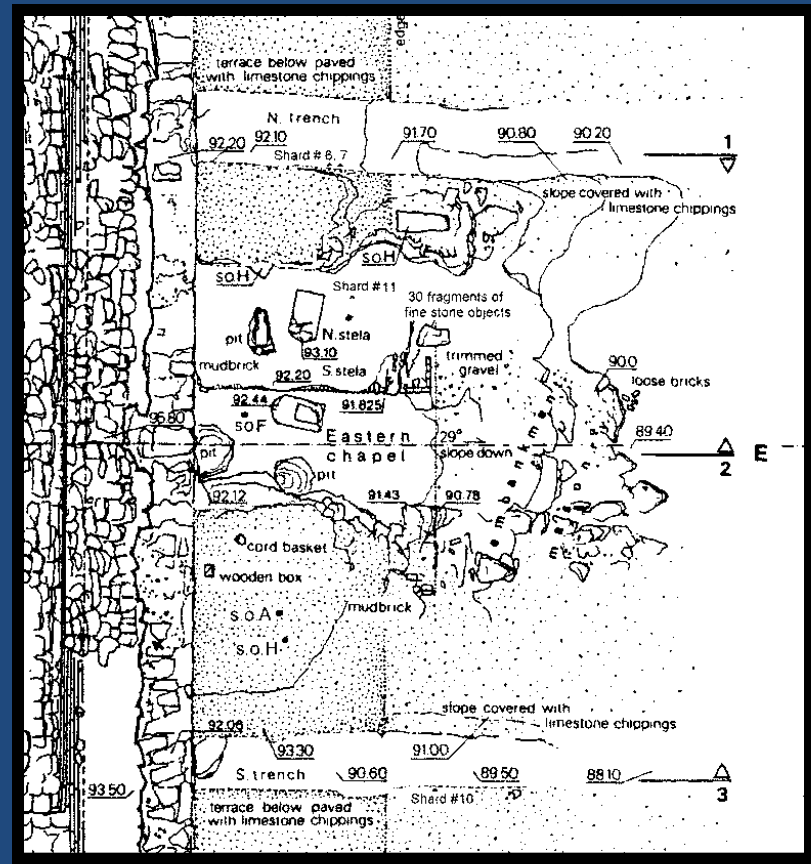
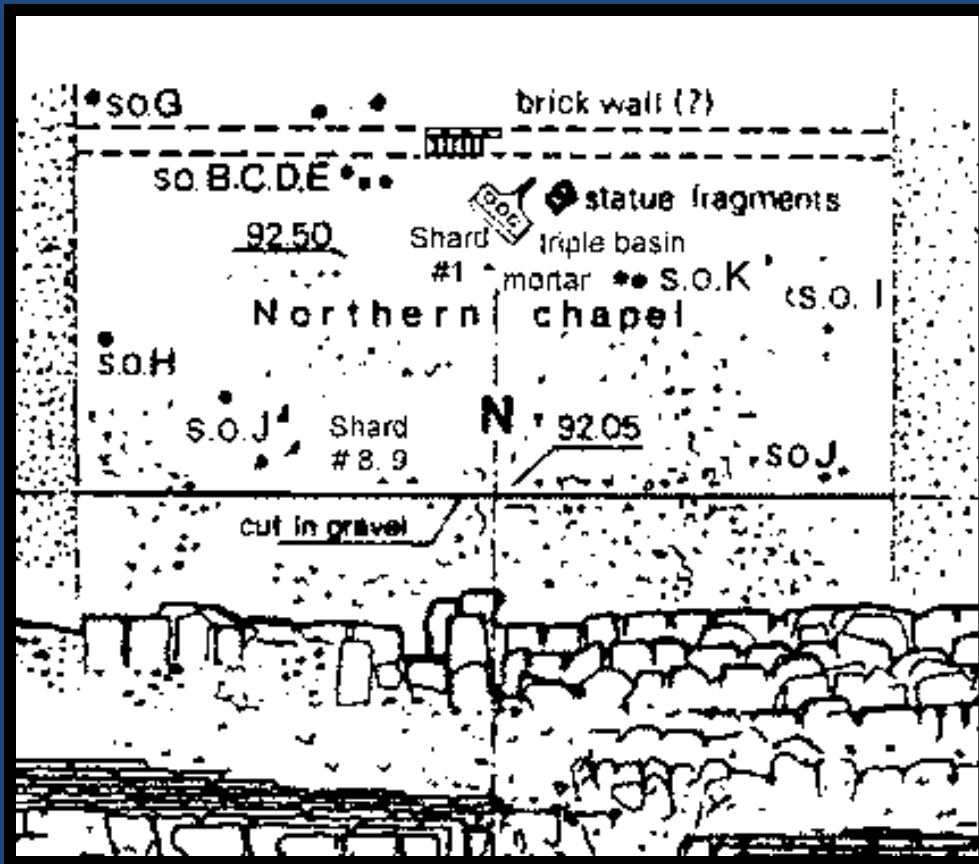

IRREGULAR LAYER ANGLES ON THE EAST SIDE

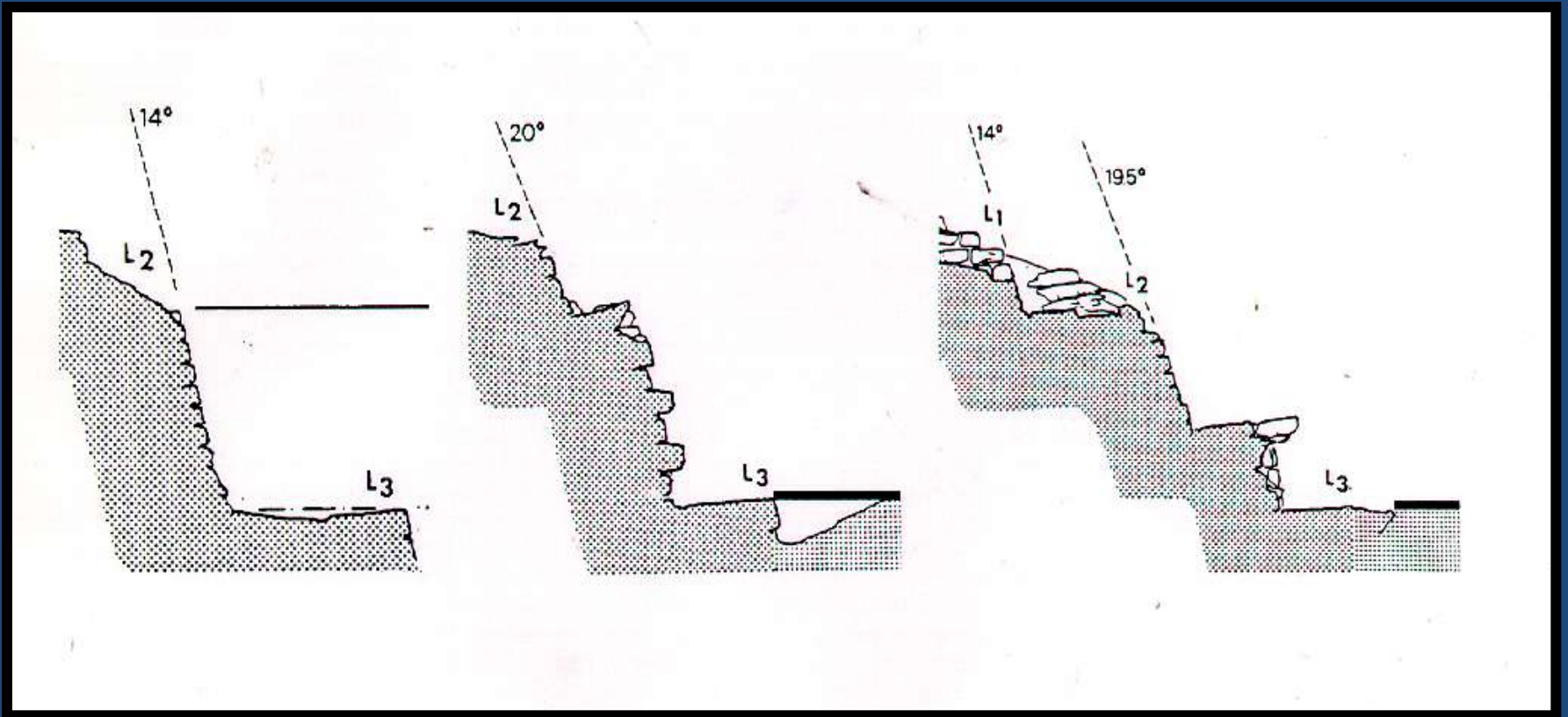

4, CORRECTING THE LAYER ANGLES

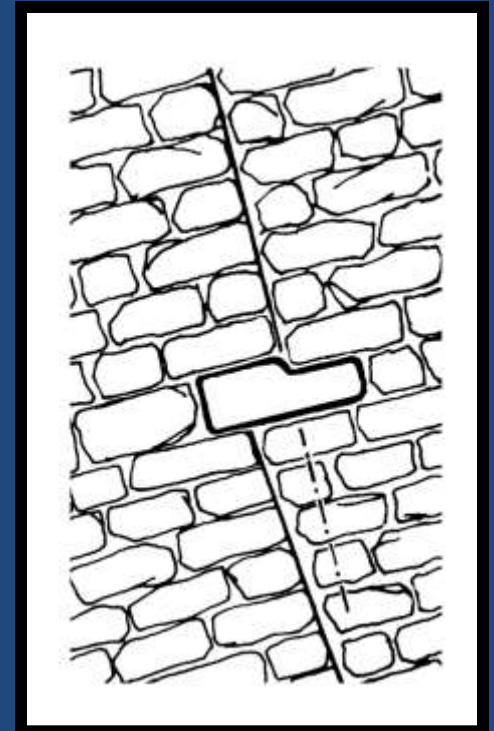
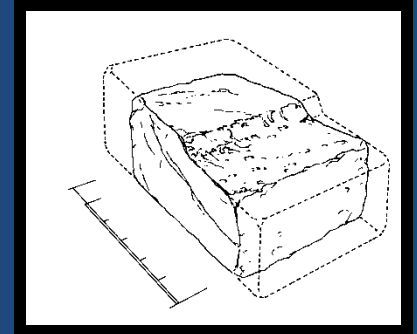
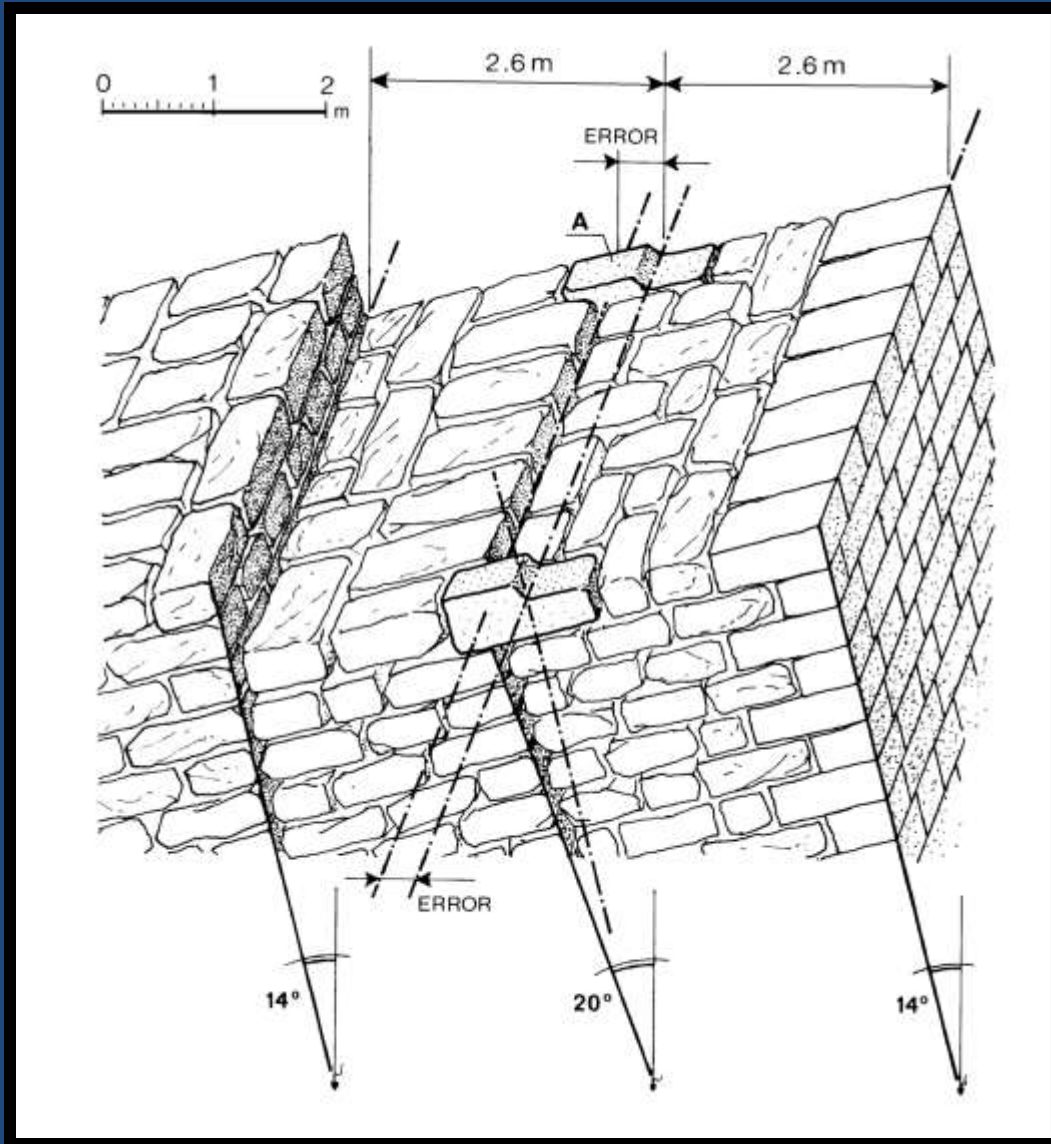

Rough Attempt to Correct a Faulty Plan at Sinki

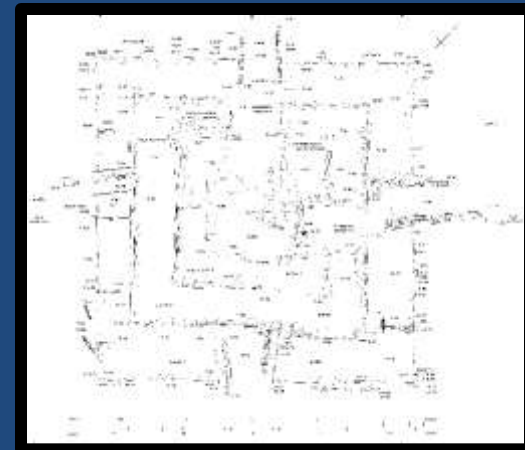
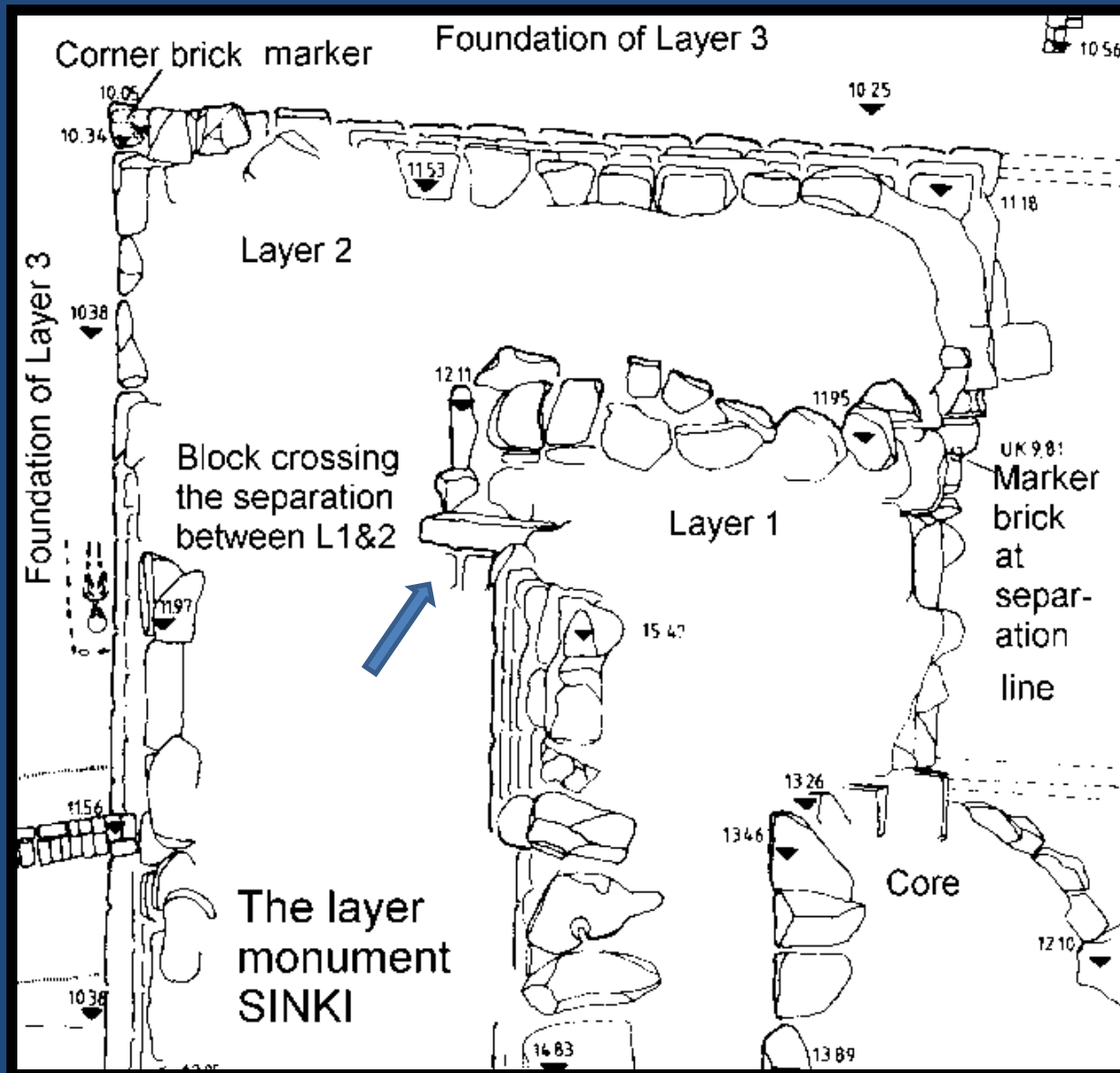

5, THE SHAPE OF THE STEP

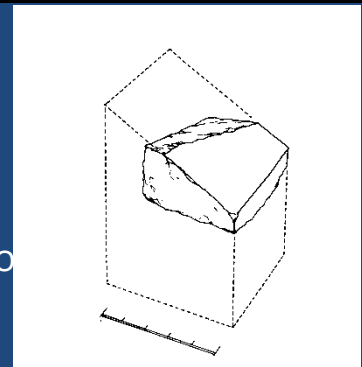
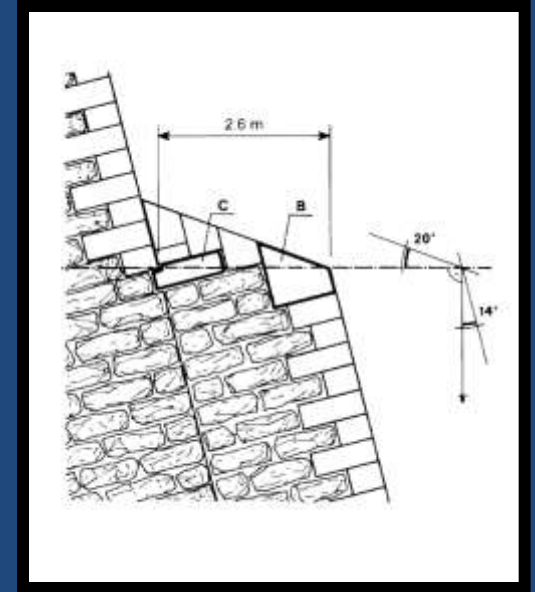
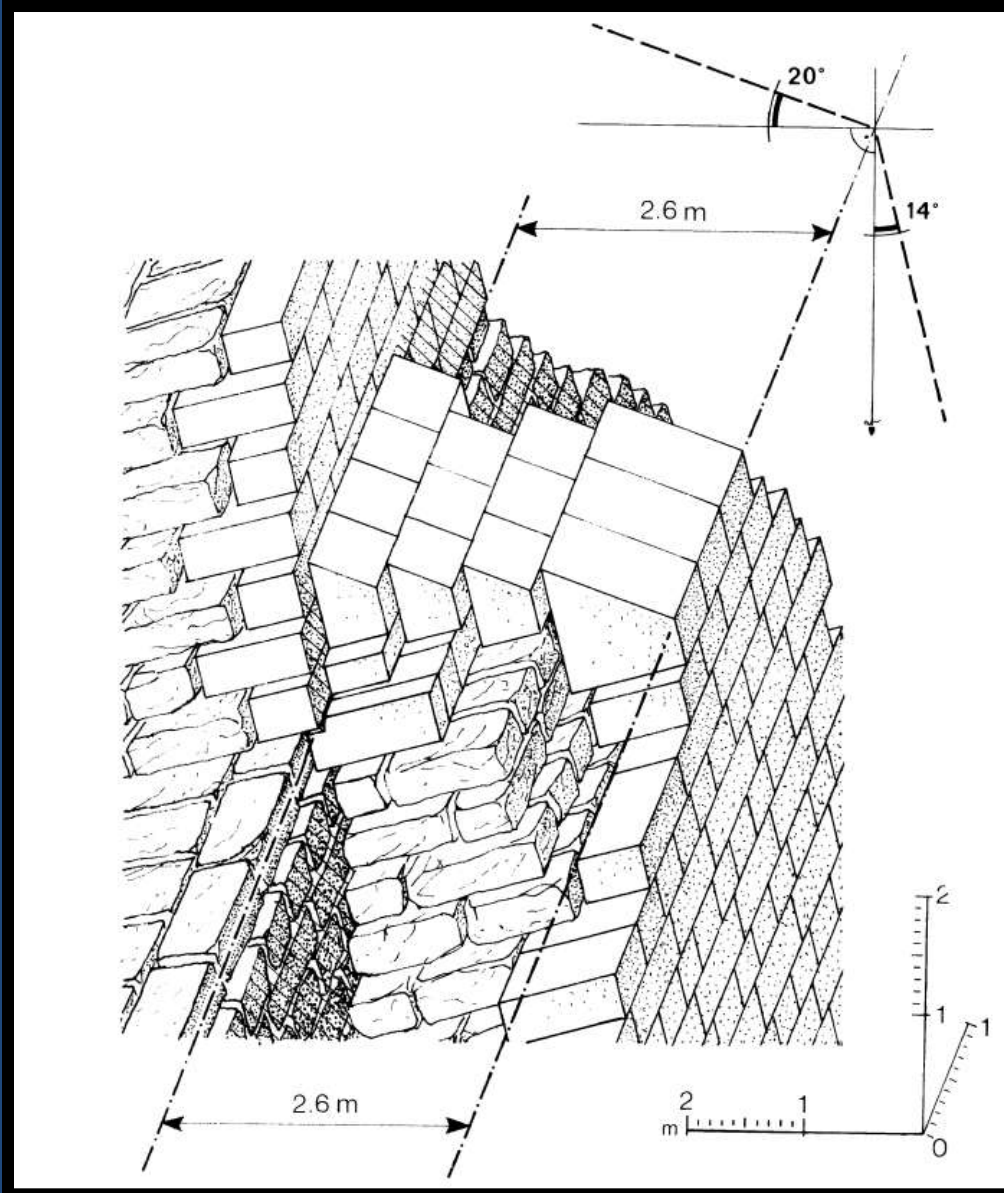

SO

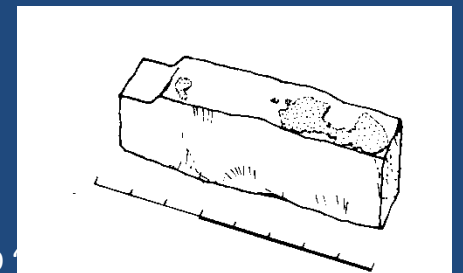

SO

6, THE ULTIMATE SHAPE

𓆎
𓆏
𓆐

An option from a Third Dynasty inscription



An option from a Fifth Dynasty sun temple

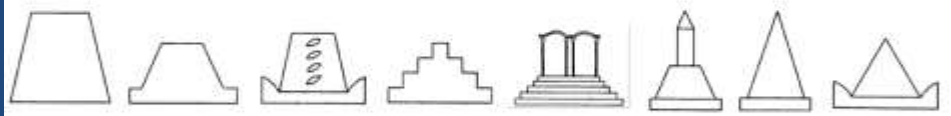

Options from the hieroglyphs for buildings

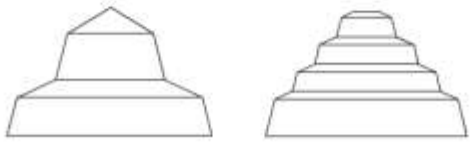

The benben and step pyramid option

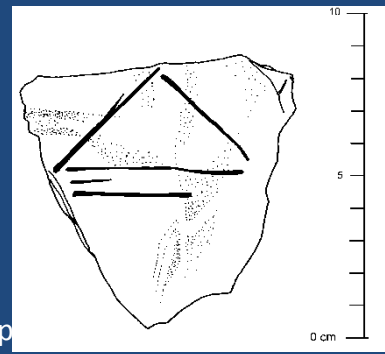

From the Northern Chap

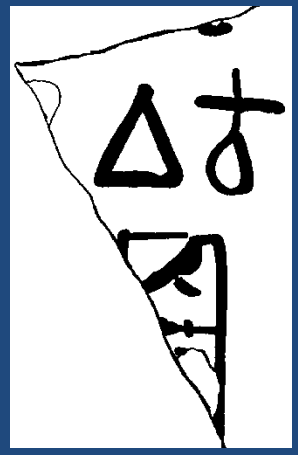

From the Step Pyramid

7, THE STEP PYRAMID OPTION



8, THE BENBEN OPTION

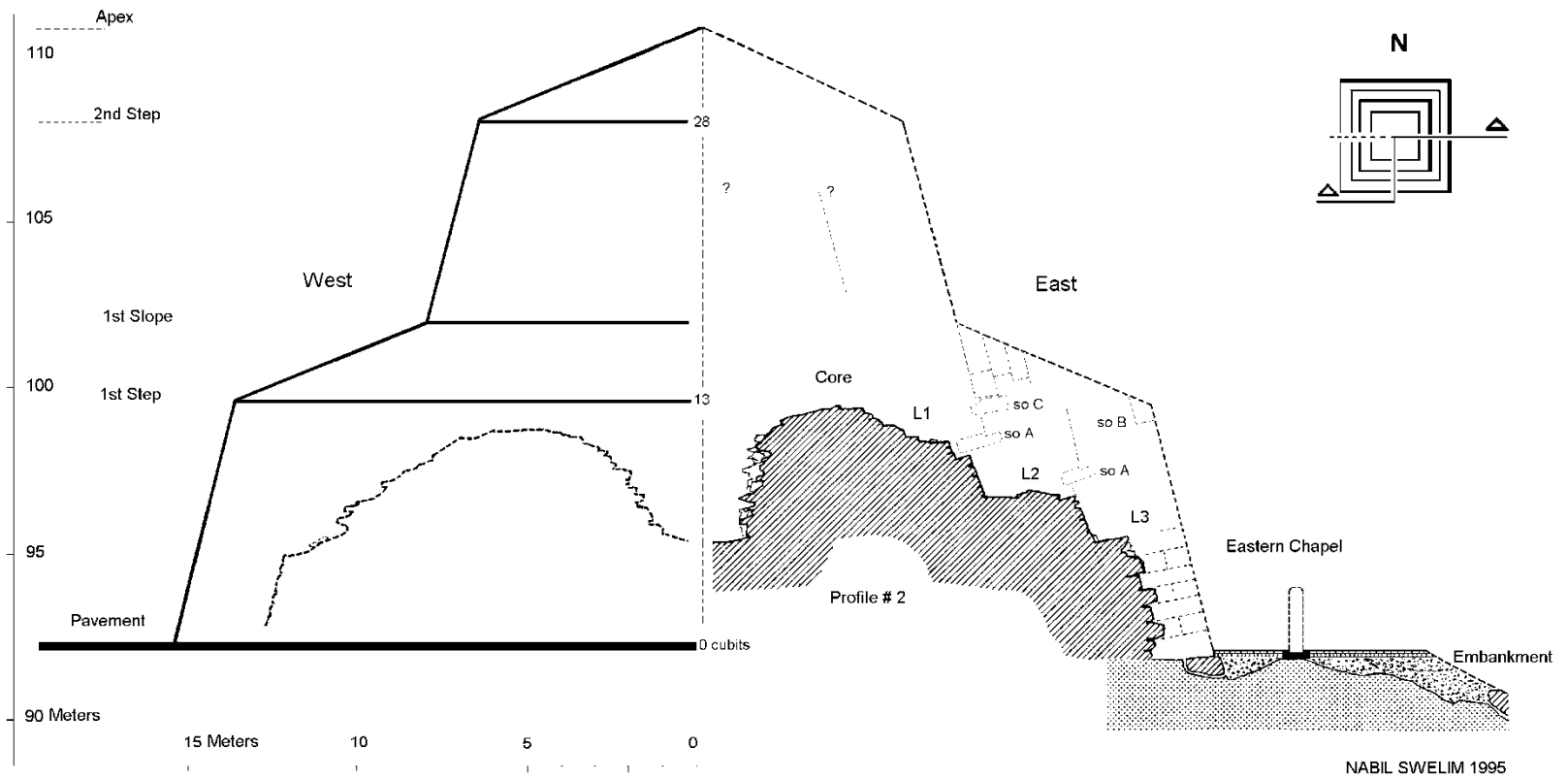

Ramps at Sinki

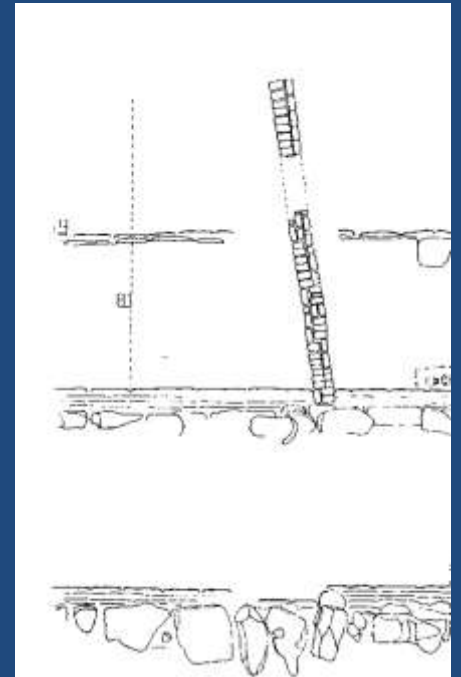
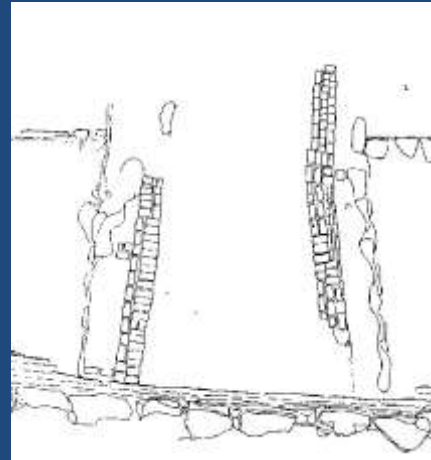
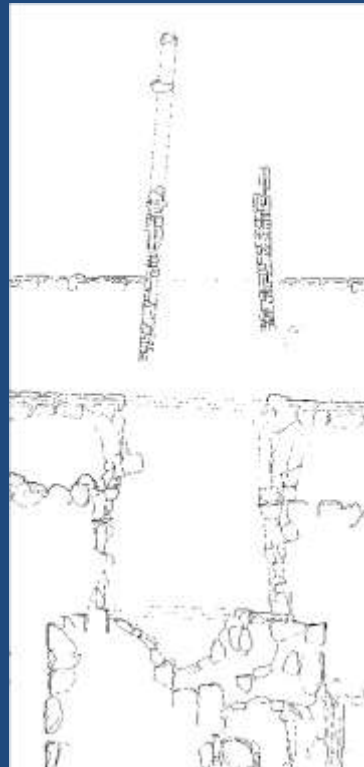

Lake Sediment, Eocene Limestone and the Pliocene Conglomerate



Seila and Sinki: Mysterious Pits

